

Varenummer: 4320000201  
Beskrivelse: Rota-fix spændelement A 20x47  
Rustfast stål

## Mål

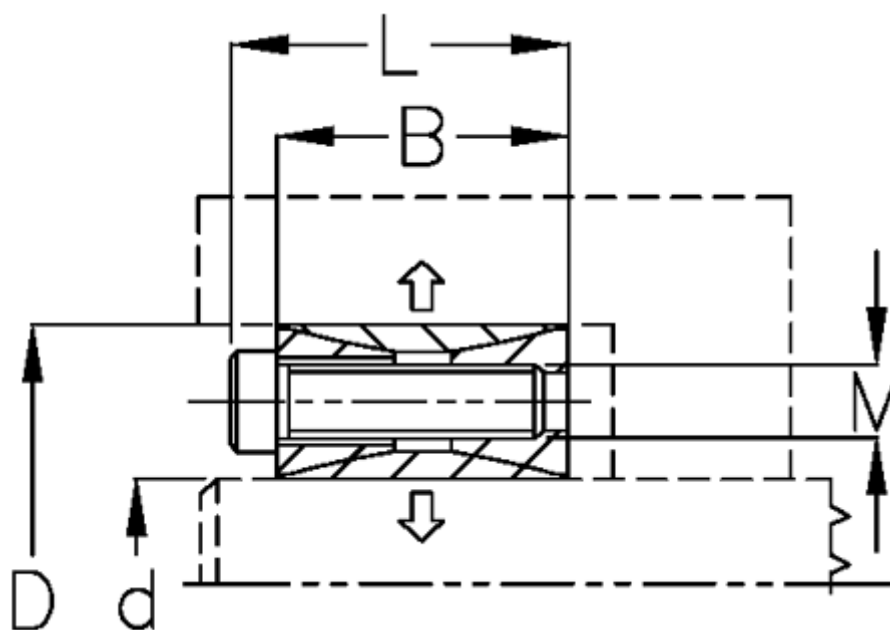

B mm	= 20
d H8 mm	= 20
D mm	= 47
F kN aksialkraft	= 16.9
L mm	= 26
M mm	= M6
Overfladeruhed	= R? ? 3.2 $\mu$ m
P N/mm <sup>2</sup> fladetryk på aksel/nav	= 31

T Nm drejningsmoment	= 160
Tolerance	= Aksel k11-h11, Nav M6
Ts Nm boltetilspændingsmoment	= 8.8